

3/8" SHOE MOUNTING FLANGE



3/8" SHOE MOUNTING FLANGE
SEE DETAIL



EX. TEAK RAIL

3/8" SS BOLTS

EX. TEAK TRIM

SUPPORT BRACKET
SEE DETAIL

INTERIOR TRANSOM WALL

4" DIAMETER STEEL COLUMN



23.125" OVERALL HEIGHT



15.125" TO TOP OF SUPPORT BRACKET

BASE FLANGE-SEE DETAIL

TEAK FILLER PLATE

TEAK DECK

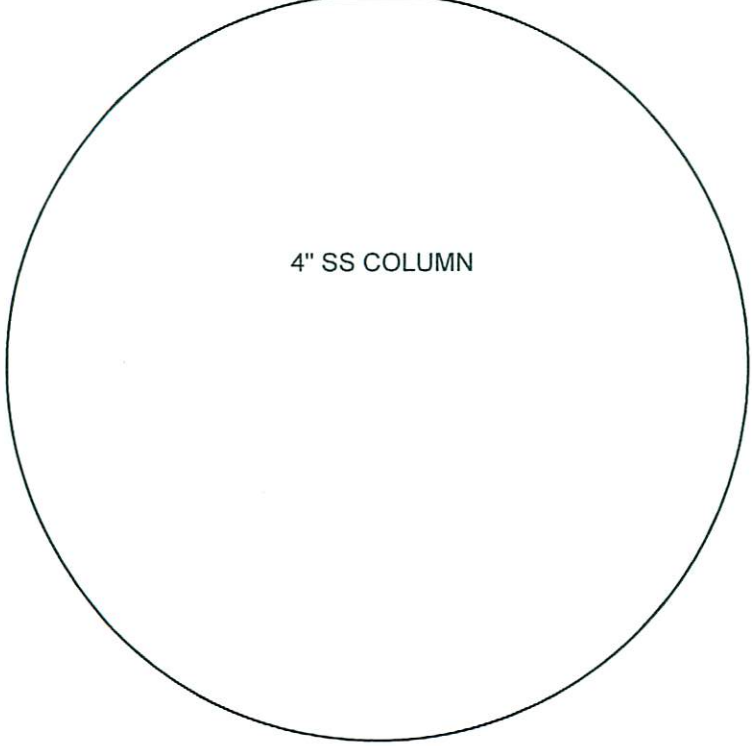
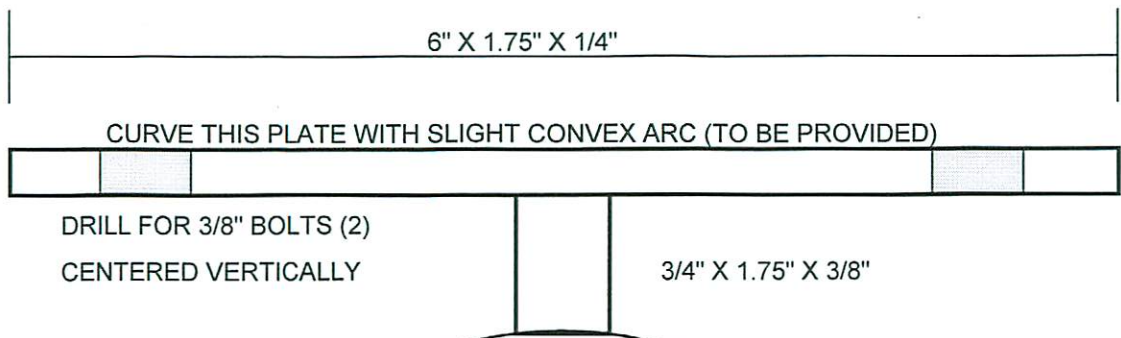

TOP VIEW

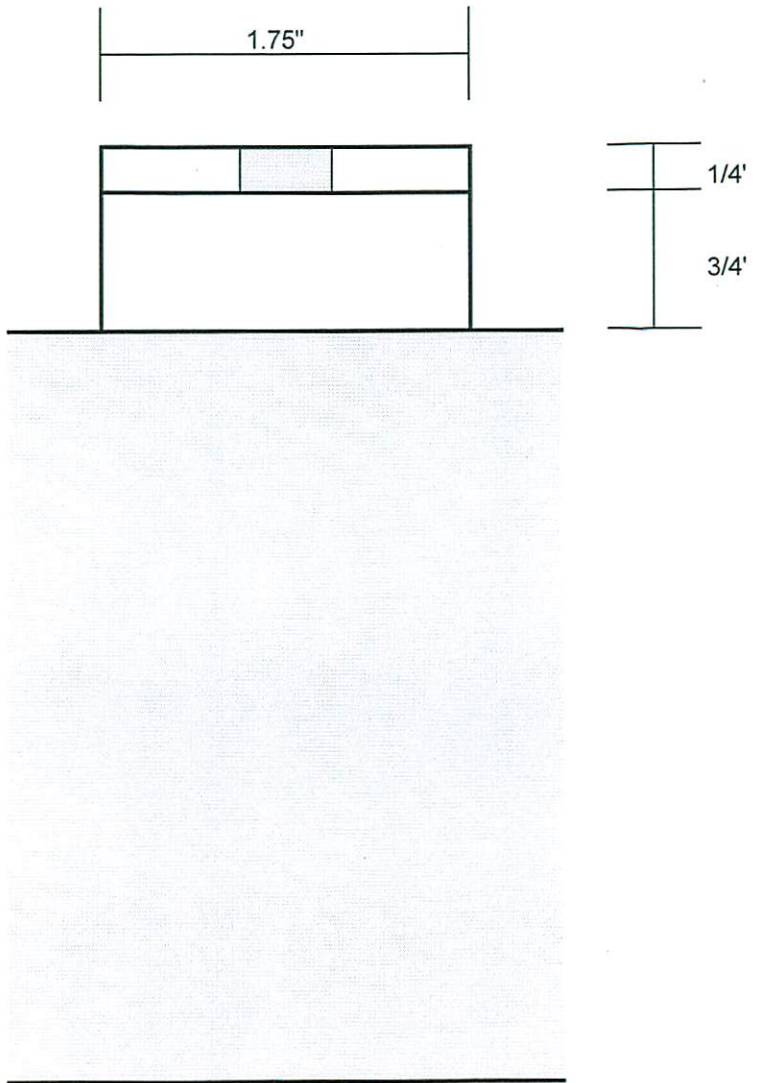

SIDE VIEW

SUPPORT BRACKET DETAIL

CHAMFER?



3/8

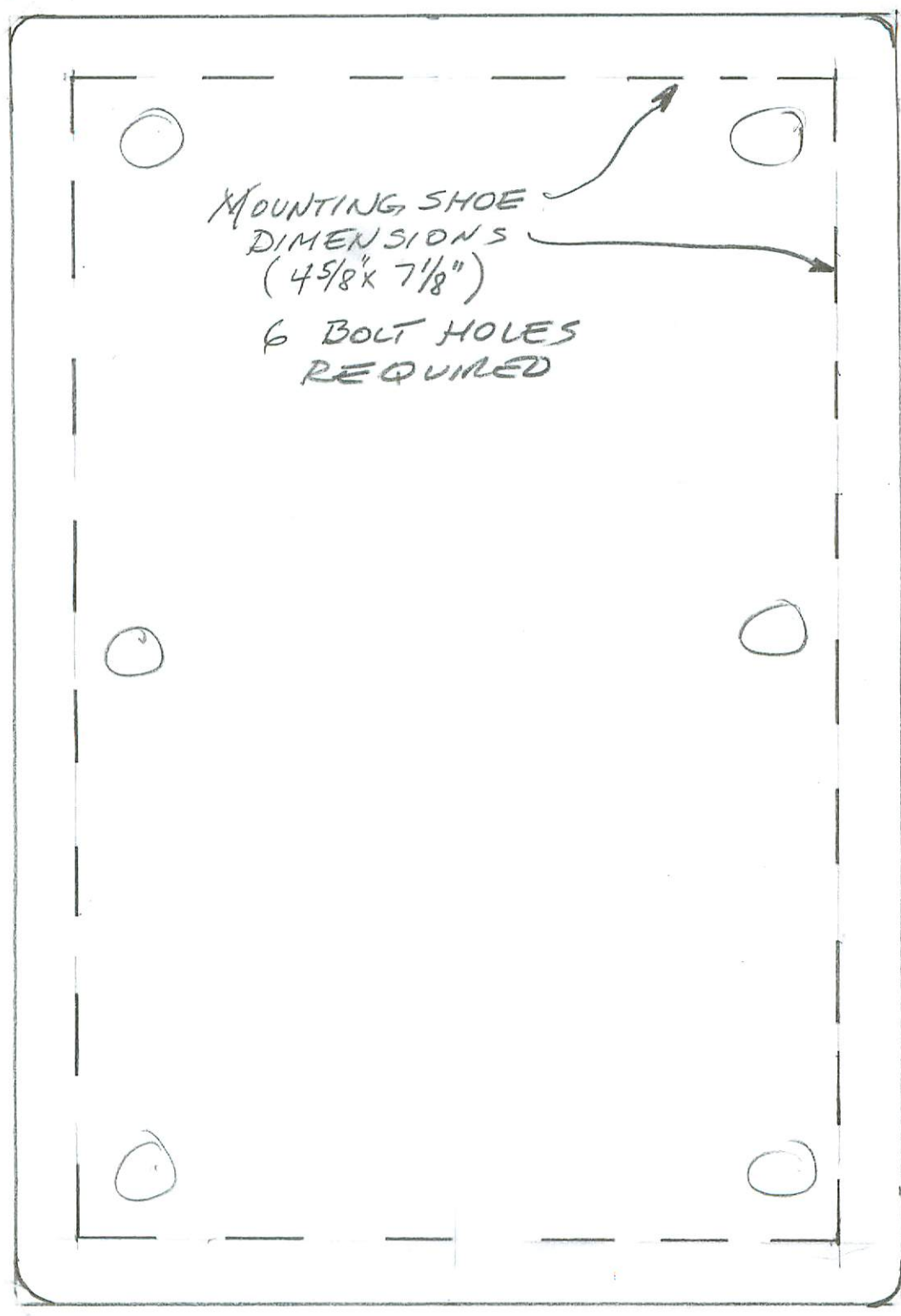

7 1/8"

5 3/8"

SHOE MOUNTING FLANGE

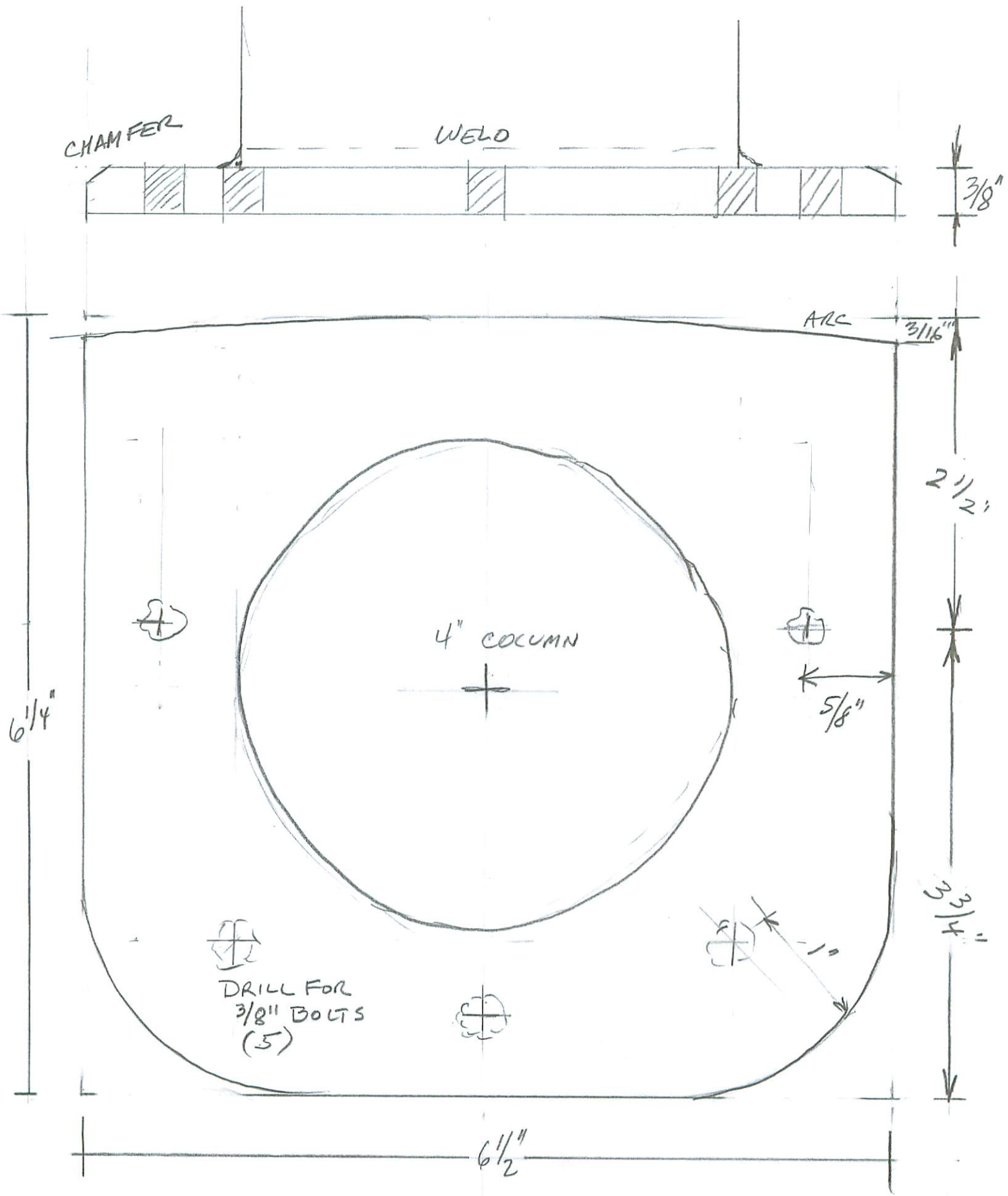

CHAMFER

WELD

$\frac{3}{8}$ "

ARC

$\frac{3}{16}$ "

$2\frac{1}{2}$ "

4" COLUMN

$\frac{5}{8}$ "

$6\frac{1}{4}$ "

$\frac{3}{4}$ "

DRILL FOR
 $\frac{3}{8}$ " BOLTS
(5)

$6\frac{1}{2}$ "

BASE FLANGE

To order call 1-800-BOATING (1-800-262-8464) or visit westmarine.com

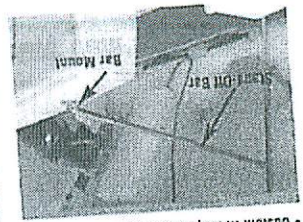

- Removable lifting arms
- Notching touches tube—it's glueless
- Custom fit for platforms up to 24" high

Length	Model	CROIX#	SMW
52"	5482068	931	2.6
44"	5482070	930	2.2
36"	5482082	929	2
28"	5482054	928	1.4
20"	5482047	927	1.1
12"	5482039	926	0.7

Sold Individually. Bar mount included.
 Only 64.99
 Enables Platform Snap-Latches to be installed or removed from transom platform as
 Model 5481916 CROIX#914 SHW 4 199.99
 Lifting Strap 79.99
 5" nylon strap aids tilting dinghy up and down.
 Model 5482096 CROIX#932 SHW 1.3 31.99

- Base slotted, dinghy can't be buffeted by water
- Polished 304 and 316 stainless steel

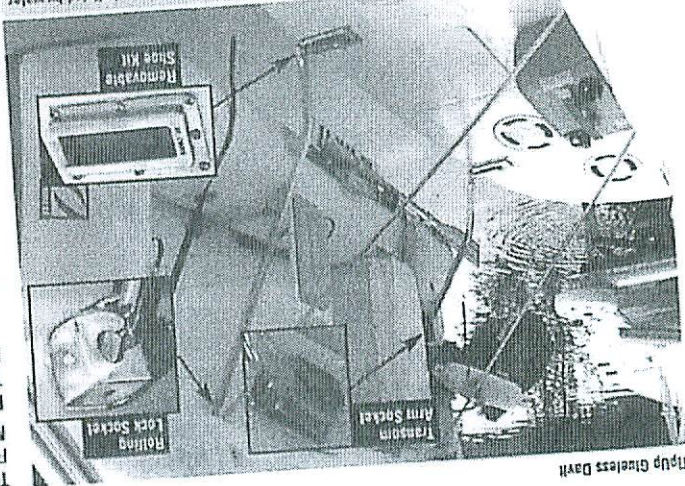

TipUp Glueless Davit

A secure way to stow ribs (or inflatable) with wooden floorboards on the swim platform. The need to glue hardware to the inflated tubes. Because the davit hardware mounts on the surfaces on the floorboards (or transom) and platform, wear due to constant flexing of at hardware as with glued-on systems is eliminated. Available in three different sizes to modulate your swim platform height above the water. Each TipUp kit includes two Platik Transom Socket, Polished 304 and 316 stainless steel components. Optional Stand-Off Latches, bow and transom Lifting Arms and fasteners, two rolling lock Bow Socket Transom Socket. A removable pin system enables bars to be carried more vertically. A removable pin system enables bars to be easily removed. An optional Shoe Kit allows Platform Snap Latches to be mounted or removed and easily.

TipUp Glueless Davit System

Platform Mounts
 Tubular stainless rails attach to swim platform. 32"H x 15"W x 15"D. Per pair.
 Model 1928639 CROIX#401 SHW 43 605.00

Transom Mounts
 For Rotating Davit Systems. 4"H x 3"W x 3"L. Sold in pairs.
 Model 413420 CROIX#414 SHW 5 145.00

Model 357733 CROIX#400 SHW 40 1325.00

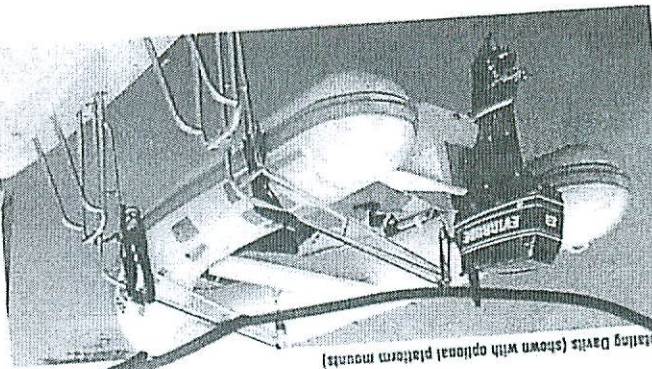

Rotating Davit System (shown with optional platform mounts)

Rotating Davit System
 Engineered and designed for years of salt or freshwater use, Rotating Davits are designed for unique requirements of boaters who need a rotating system. Ideal for sail or powerboat. Rotating Davits incorporate a fixed upper block welded as a structural component of the davit. Davits will lift and carry 300lbs. per pair with a 9:1 mechanical advantage. From 1" (25mm) 316 tubular polished stainless steel, these davits install to any stern rail and to the transom. Ball and socket lower mounts and unique "free-rotation" rail brackets reduce stress under any sailing condition. The upper mount is a clamshell that attaches to either rail or a vertical surface. The davits rotate to compensate for non-square applications. The lower is an adjustable ball joint that will pivot up to 26 degrees. The mounting surface of the davit is a 3" x 3". Each system consists of two each of the following: davit arms, integrated cleat joints, integrated upper pulleys, lower pulleys, hooks, and clamshell mounts for 1" rails.

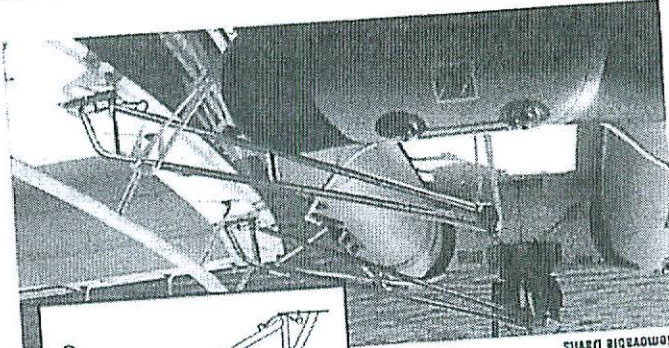

Removable Davits

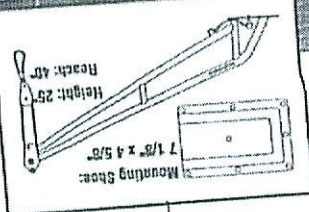

Removable Davit Accessories
 Lull Railing 225lb. 350lb.
 Purchase 7:1 9:1
 Model 357691 447748
 CROIX# 250 300
 SHW 28 28

Hypon D-Rings (pair) 1974484 222
 Model 1974500 223
 CROIX# 0.4 0.6
 SHW 1 3

Two Point Eyebolt Kit 357774
 Model 357790
 CROIX# 242

Ratchet Tie-Down Restraints (pair) 357790

integrated upper pulleys, mounting shoes, lower pulleys, hook, integrated cleats and...
 not exceed the 350lb. limit). Each system consists of two each of the following parts:
 a 15hp outboard (providing that the total weight of the boat, motor, gas tank and equipment
 ing finish. Rated 225 and 350lbs. per pair and designed to carry a 10 or 11' inflatable motor
 for the marine environment, the 1" (25mm) 316 tubular stainless steel is mirror polished for
 pull the locking pin on each davit and slide it out of its shoe. Engineered
 your swim platform and stern completely clear and ready to use. Just
 discriminating boaters. Launch your tender and just seconds later, have
 Quality, design and ease of use make Removable Davits the choice of

Boats & Engines

St. Croix Davit Systems

